



DIGITAL DISPLAYS

DDV Touchscreen Digital Signage



User Manual

Table of contents

Assembly guide.....	2
Remote control guide.....	3
Quick start guide.....	4
Updating content via USB.....	5
Updating content via LedArt app.....	6
Additional LedArt features.....	9
Digital screen system settings	15
Unit specifications	21
FAQ	22

Digini is a registered trademark of the parent company UK Point of Sale Group Limited
(company number 03833656)

Assembly guide

Standard unit components included:

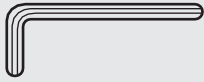

2x Allen keys



8x large Allen screws



x4 adjustable feet

Screw each of the four adjustable feet underneath the base

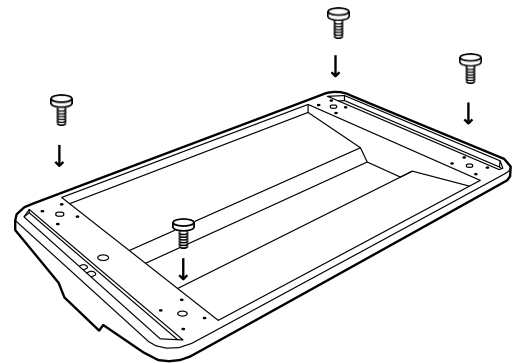

Screw in the eight Allen screws to securely fix the screen and the base together

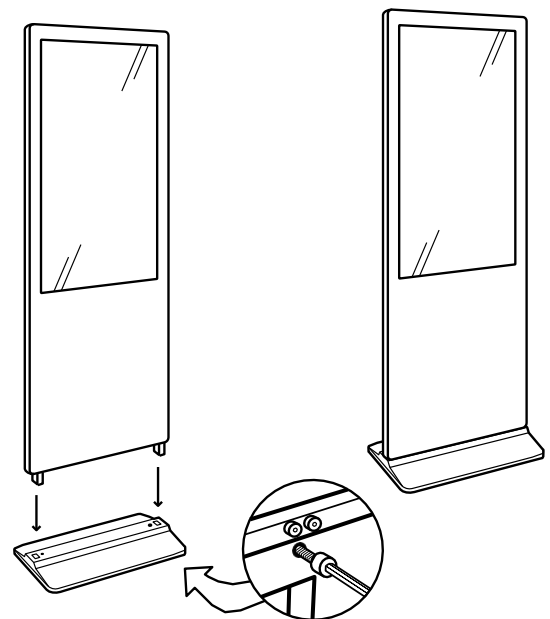

Underneath base: 8 screws total

Remote control guide

Enter the system settings by using a remote. The function of the remote control buttons is as follows:



Quick start guide

There is a default slideshow loaded to the machine. To update this, use the "Turn on Magicplayer" button on the remote control and then press the "Magicplayer menu" button to enter the system settings:



The Magicplayer interface is as follows:

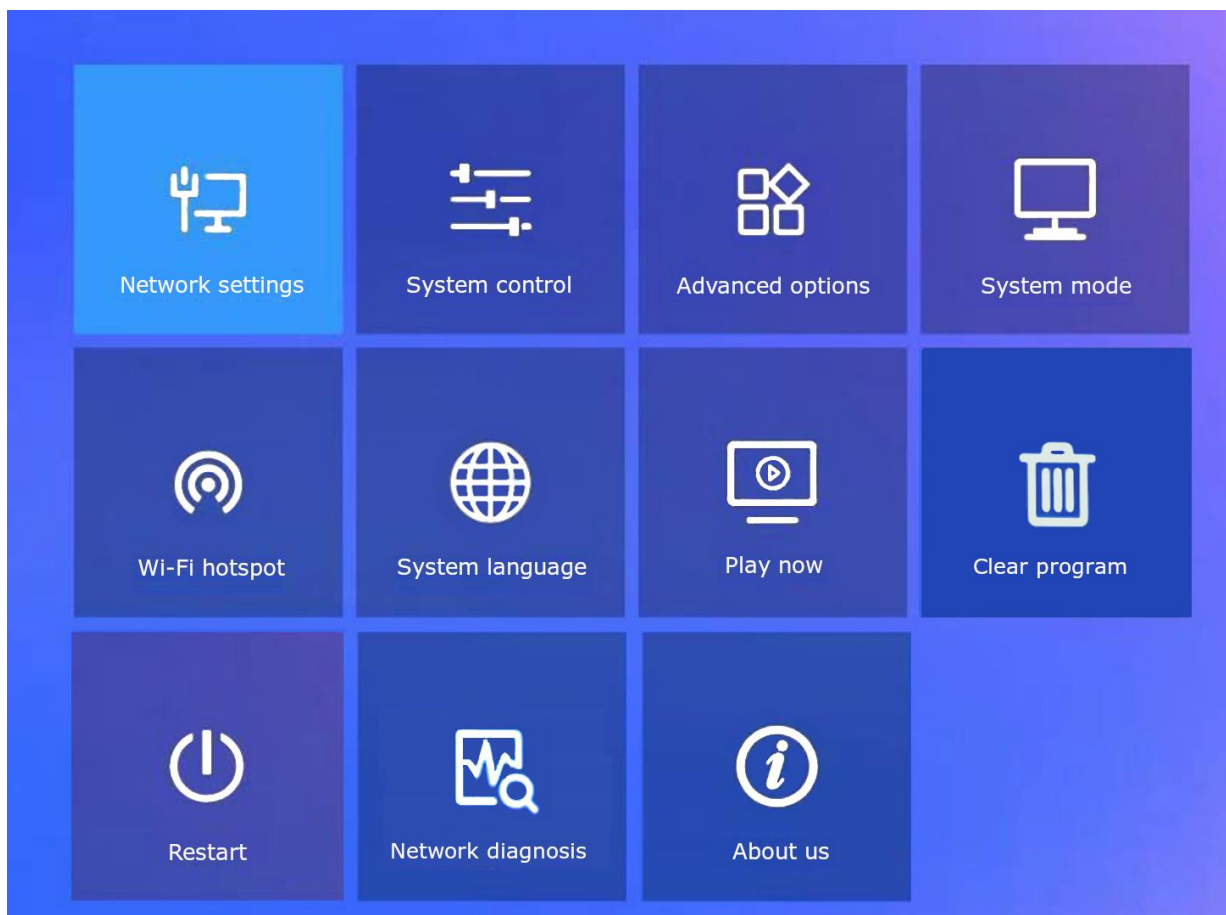

Select "Clear program" to remove the default slideshow.

You will now see the following Magicplayer home screen, which is the default when no slideshow is loaded.

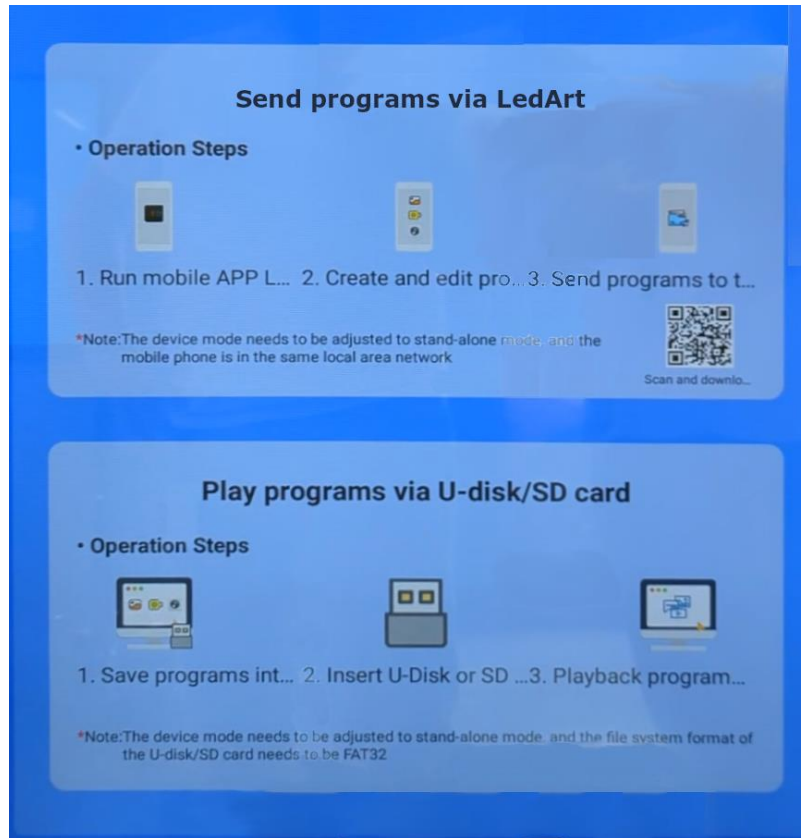

See the following pages for instructions on how to either update content via USB plug-and-play, or how to update content via the LedArt mobile app.

Updating content via USB

The quickest way to get started with your screen is to store videos and images in your USB stick. Once plugged in, they will automatically play in a loop.

This PC > USB Drive (H:)

Name	Type	Size
002.mp4	MP4 File	4,524 KB
Touch_The_Sky.mp4	MP4 File	42,506 KB
41.jpg	JPG File	1,539 KB
42.jpg	JPG File	1,238 KB
43.jpg	JPG File	1,063 KB
1111.png	PNG File	66 KB

Updating content via LedArt mobile app

Required phone system: Android 4.0 and above or iOS 7.0 and above



LedArt installation

Users can scan the QR code to download the LedArt app, or search for "LedArt" downloads in Google Play Store. After downloading the app to your phone, you can install it by default



Digital screen Wi-Fi connection

Magicplayer turns on Wi-Fi hotspot on your digital screen

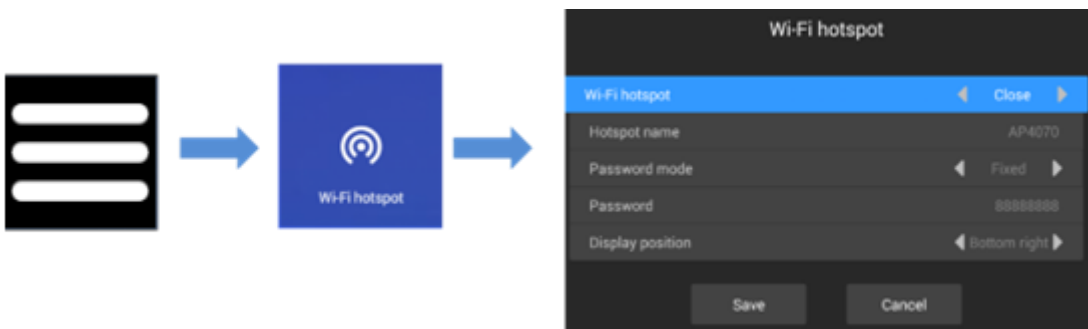

Press the menu key on the remote control, select Wi-Fi hotspot, and select "open" to turn on the Wi-Fi hotspot.

At this point, you will see the machine's hotspot name, and a default password (which can be changed).

Note: If you use a network cable to connect to the LAN, skip this step.

LedArt Wi-Fi connection

Open the LedArt app on your mobile phone. Select the "Device" section (along the bottom of the screen), click "Find device", and then connect the corresponding Wi-Fi hotspot. You can then return to the LedArt app home page.

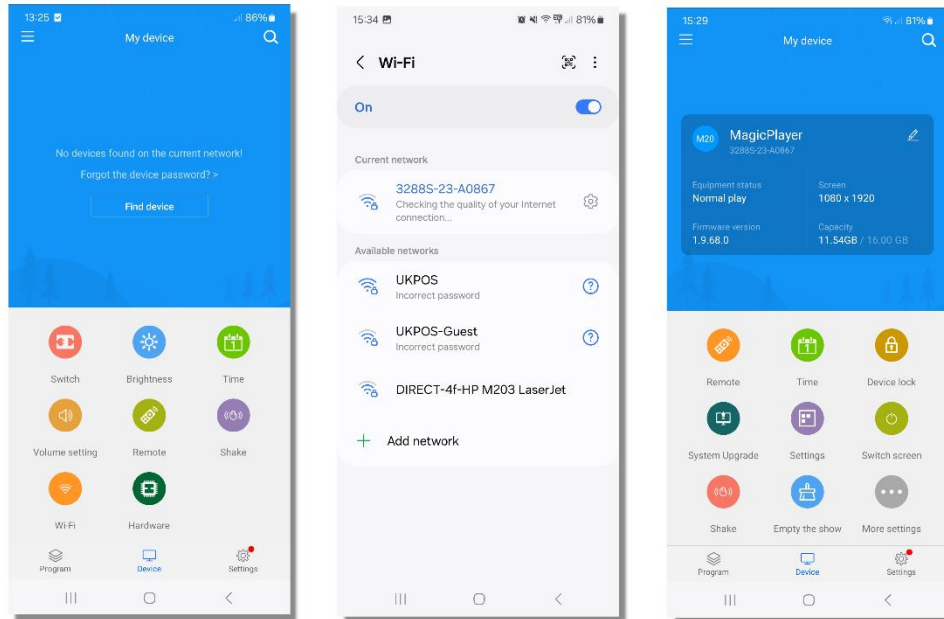

You can also connect to a Wi-Fi hotspot in your phone's "Settings" WLAN.

To create a new program

Select the "Program" section (along the bottom of the screen), click "New Display" then "Add". This will allow you to add content. You can also rename the screen if necessary.

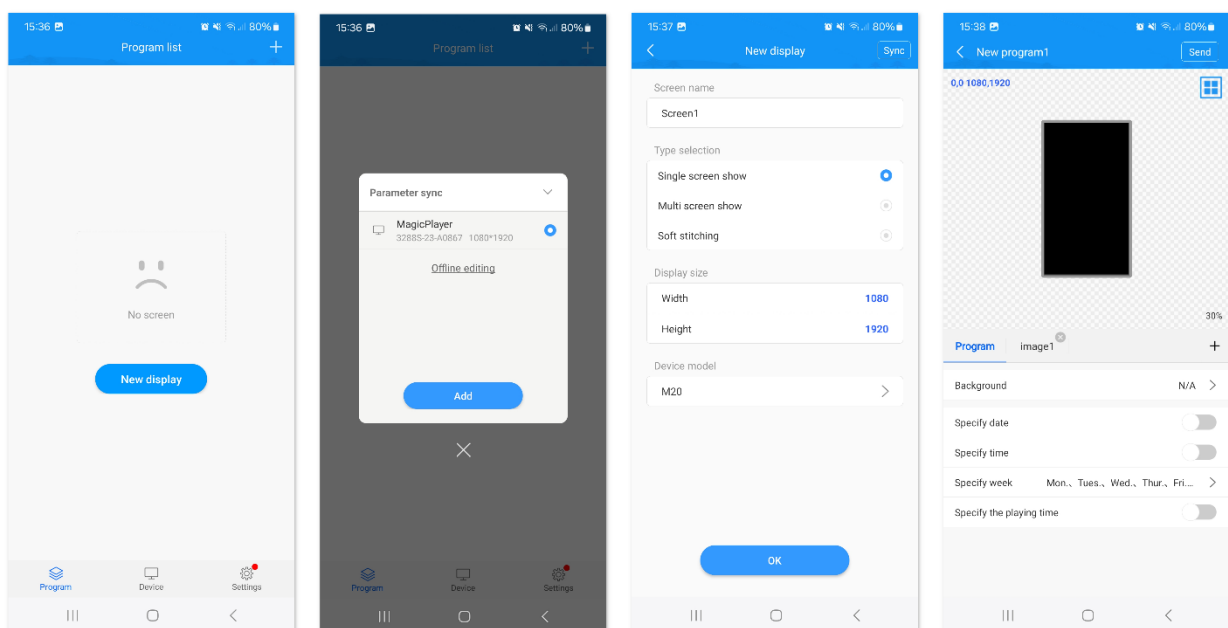

Add images and/or video

Click the "+" on the right to add a video or image. You can then manually enlarge the area if required, and then click the "+" at the below left to add multiple images or videos. Your pictures and video are played in a loop.

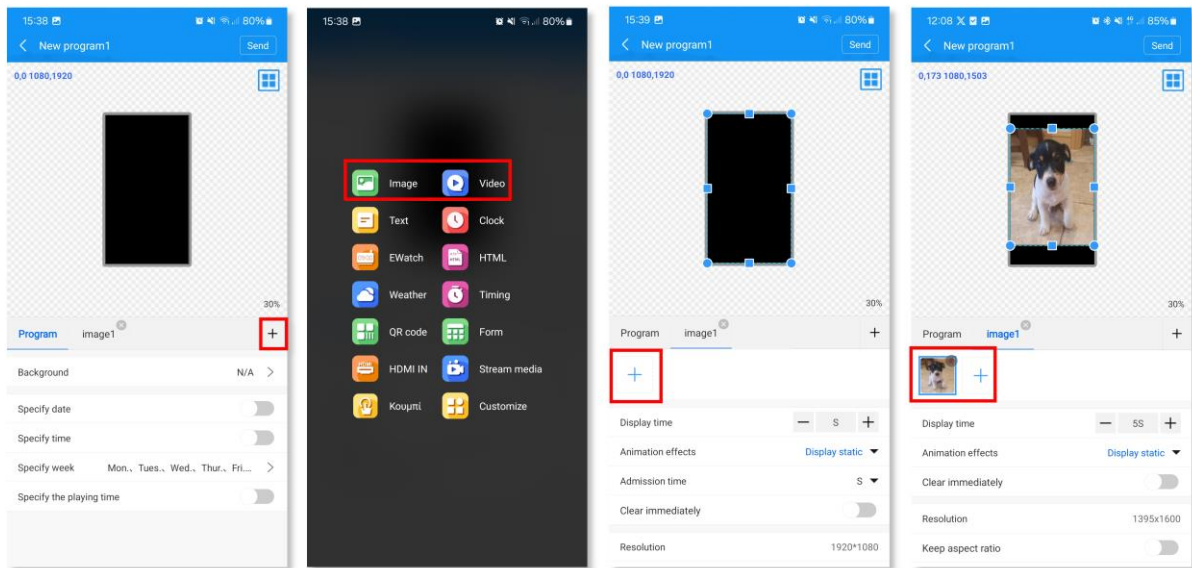

- Once content is added for your program, press send (at the top right of the screen). This transfers the display to the unit, and you're free to walk away.
- If you want to display multiple programs, return to the program list, where you can add and send multiple programs.

Additional LedArt features

Add text

Click "+" on the right to add a text area, then enlarge the text area in the simulation display area, and then enter the text to be played in the text input box below.

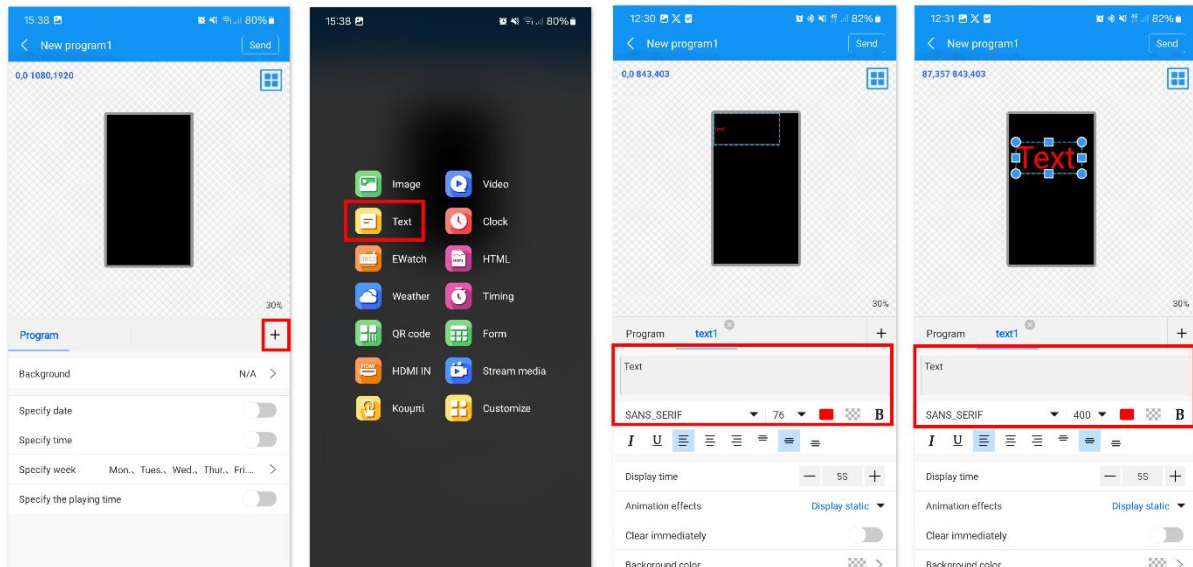

Below the text input box, you can modify the font type / size / color, text display duration, animation effects, and background color (swipe up to see).

Time display

Click the "+" on the right to add the clock area, and then enlarge the clock area in the analog display area. The clock text size is automatically adjusted according to the height of the area.

Below, you can choose to display date, day, seconds, modify font type and size.

Text and time can be displayed on a screen on their own, or overlaid onto your images and videos as explained in the next section

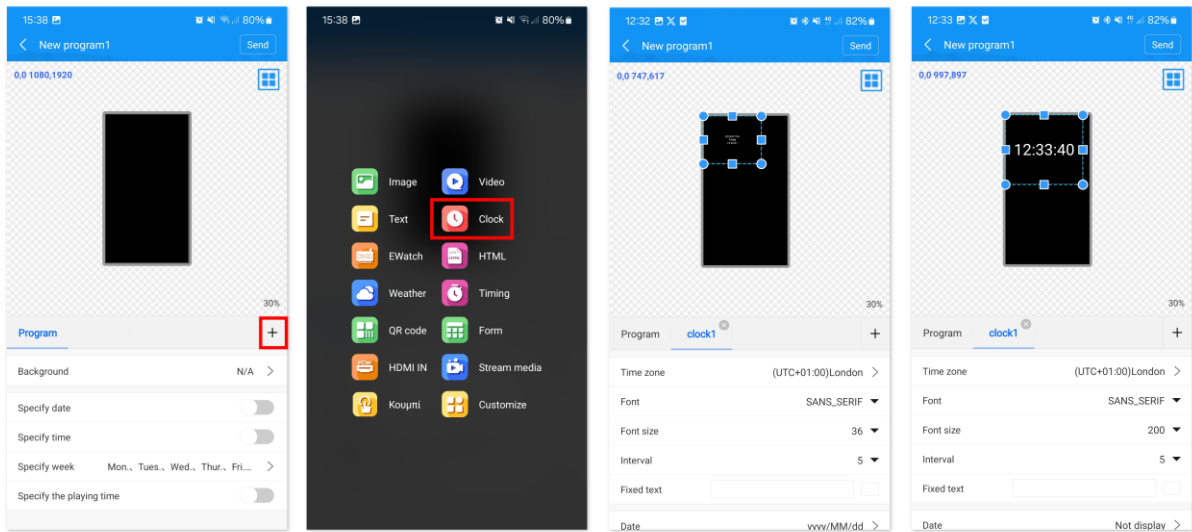

Layer overlay

The bottom image or video layer is added first, and the overlays added later are displayed on top.

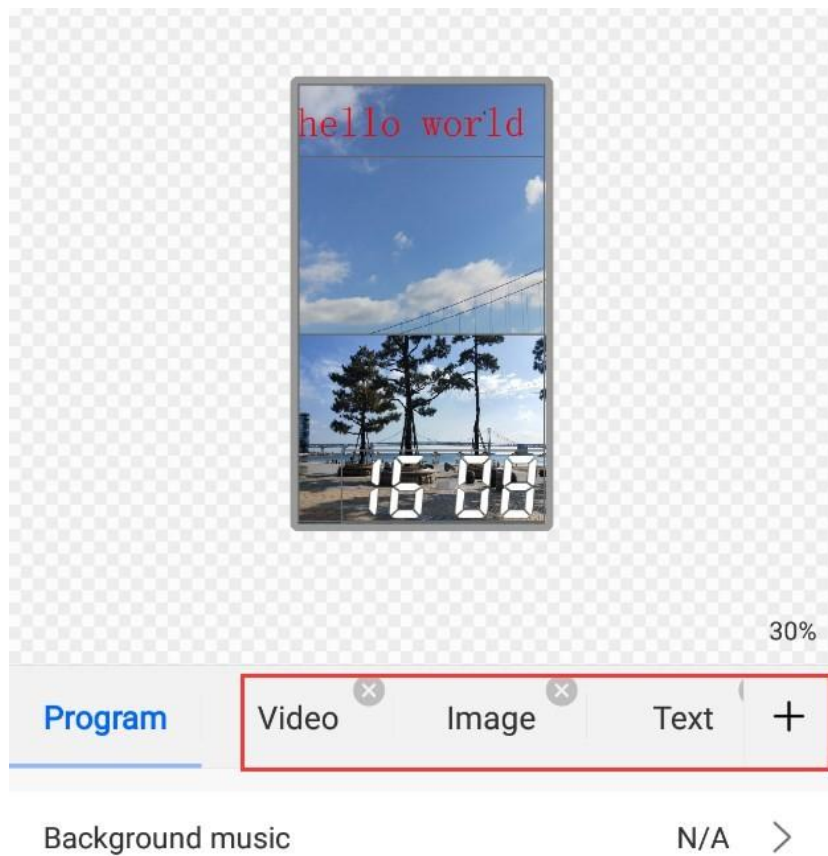

Features:

- Each area can be enlarged and reduced and dragged
- The background of text and clock is transparent by default, so you can add video/image as the background of text/clock first
- It's possible to add up two video areas at the same time, using the split-screen function, while overlaying your text, time etc.

Program broadcast control settings

Select "Program" on the left side of the program editing interface, and you can set the background music, broadcast date, broadcast time, broadcast week, and broadcast duration of the below.

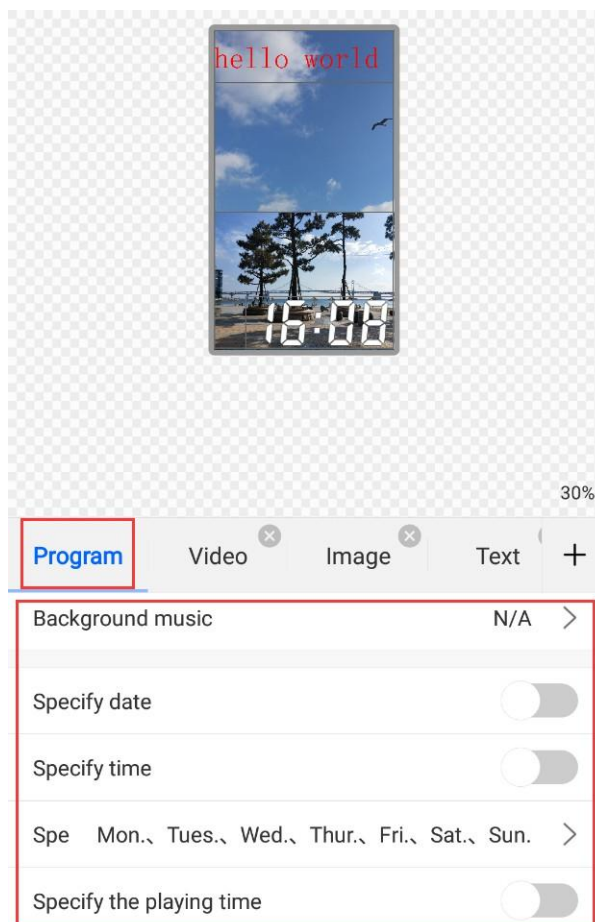

Using the LedArt remote control function

In the LedArt app on your phone, select the "Device" section and click "Remote". You can use the remote control functions to switch your display on/off, change to previous/next program, pause/play, adjust volume and adjust brightness, etc.

When connected, you should be able to see the following screens:

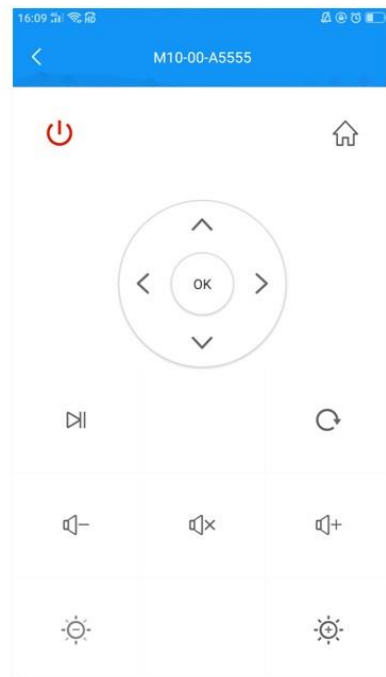
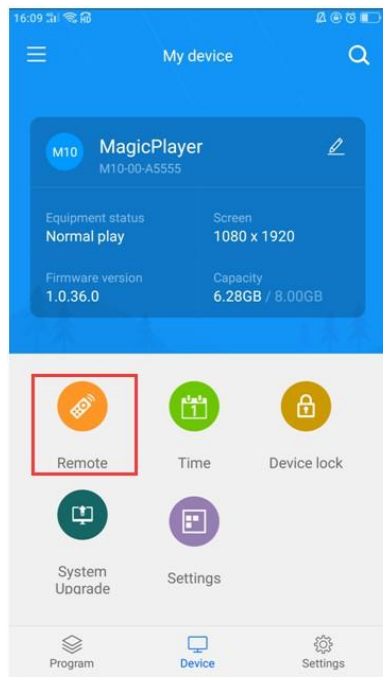

 ON/OFF

 Select up or previous show

 Select up or previous program

 Confirm

 Back

 Volume decrease

 Brightness decrease

 Home

 Select down or next show

 Select down or next program

 Play/Pause

 Mute

 Volume up

 Brightness increase

Time correction

Select the "Device" module and click "Time Correction" to correct the time.

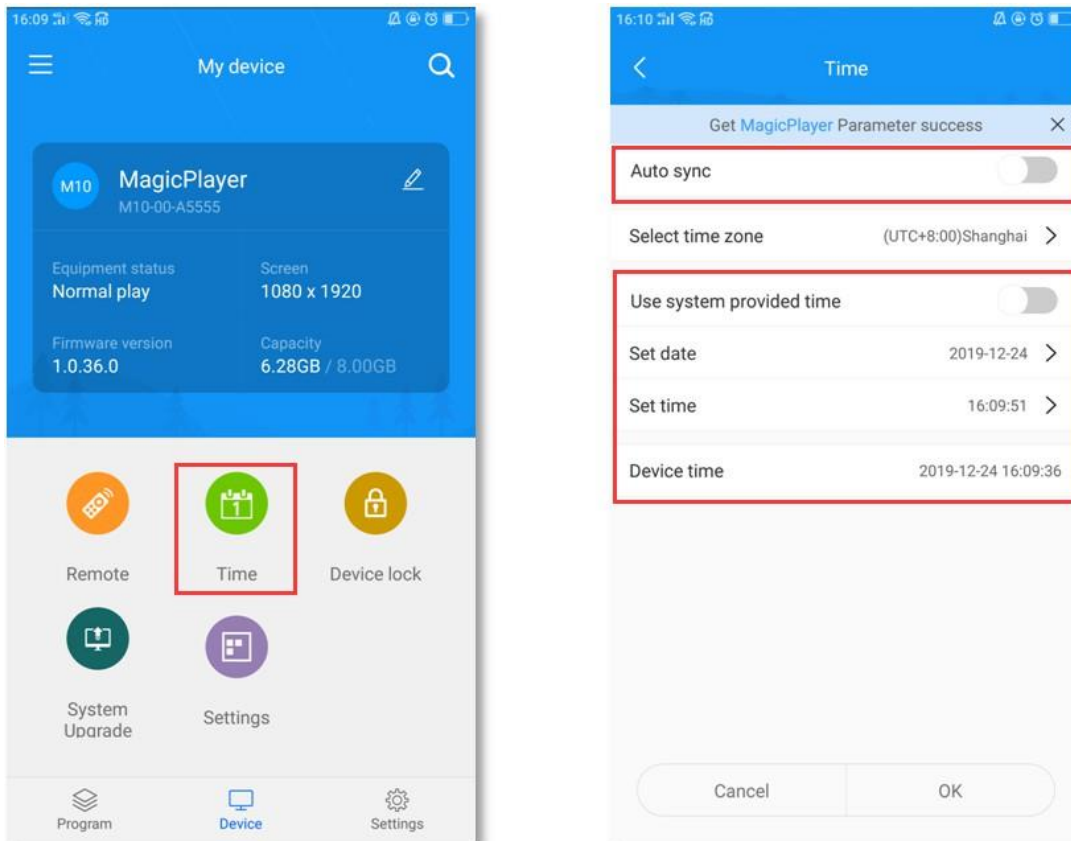

There are three time modes:

- Automatic synchronization, if the controller is connected to the Internet, turn on this setting, the time can automatically synchronize the Internet time
- Use the date and time of your phone to synchronize the time on your phone
- When neither of the above two settings are enabled, you can manually modify the time

Device lock

Select the "Device" module and click "Device Lock" to turn on the device lock. Each time you send a program, you need to enter the correct password to send it.

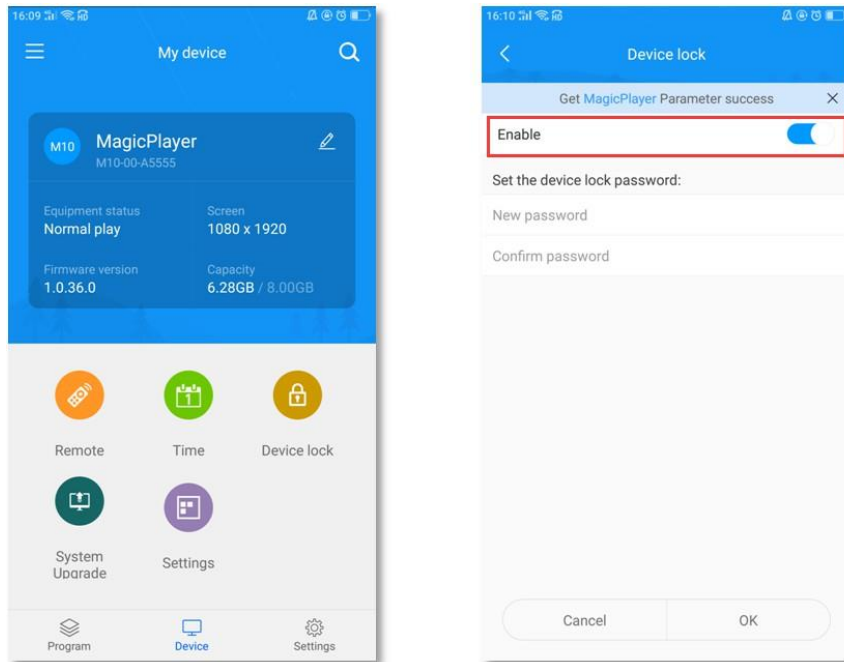

System upgrade

Select the "Device" module, click "System Upgrade", and select a version to upgrade the system

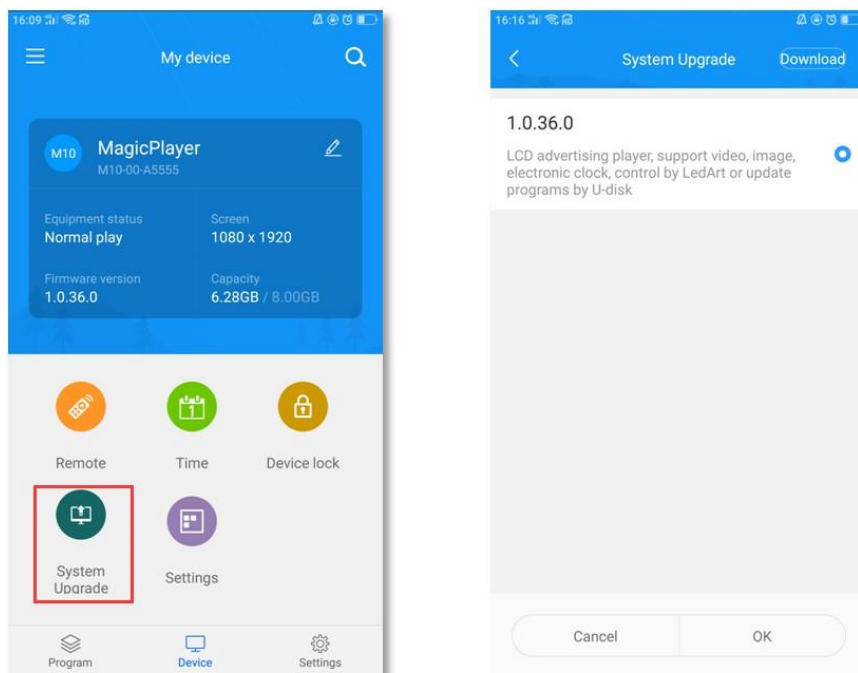

Note: The version needs to be downloaded in "Download Management" in the "Settings" module.

Digital screen system settings

1. Network settings

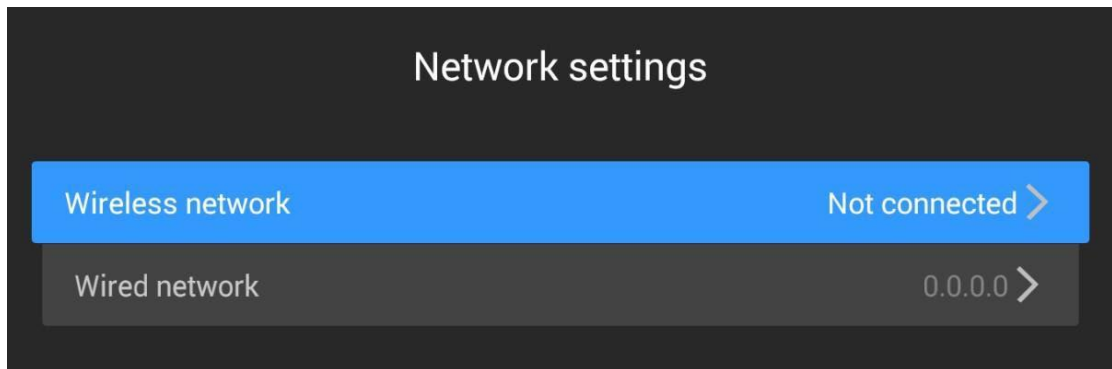

- **Wireless network:** The controller is bridged to other routers via Wi-Fi signals, and the IP address is automatically obtained from the router. It cannot be set to a fixed IP
- **Wired network:** The controller is connected to other routers through a network cable. The IP address can be obtained automatically from the router or it can be set to a fixed IP

2. System control

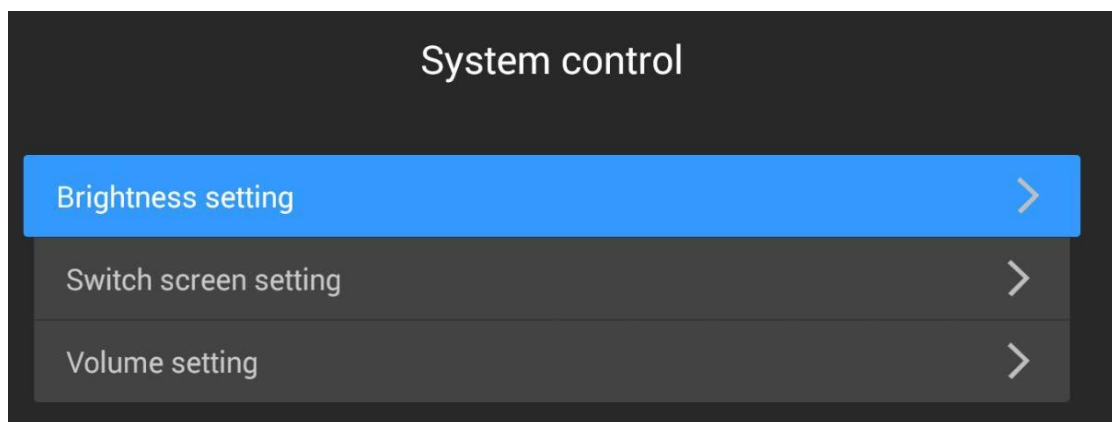

- **Brightness setting:** adjust LCD screen brightness (requires LCD panel support)
- **Switch screen setting:** set the switch time of the LCD screen
- **Volume setting:** Adjust the volume of the LCD screen

3. Advanced options

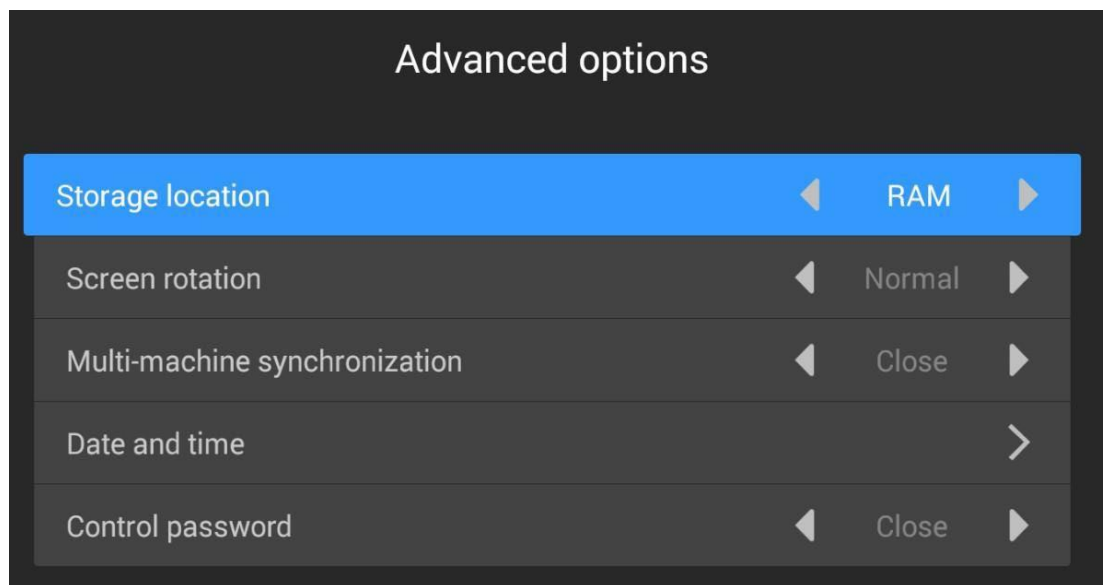

- Storage location: where the program is stored; (sending programs by app)
- Screen rotation: support LCD screen rotation of 0°, 90°, 180° and 270°
- Multi-machine synchronization: multiple LCD screens play the same content and play the same progress
- Date and time: Set the date and time of the player. When the automatic adjustment is turned on, the internet time is automatically synchronized (requires internet access)
- Control password: Password control means that a password will be required when entering the system setting interface from play mode

4. System mode

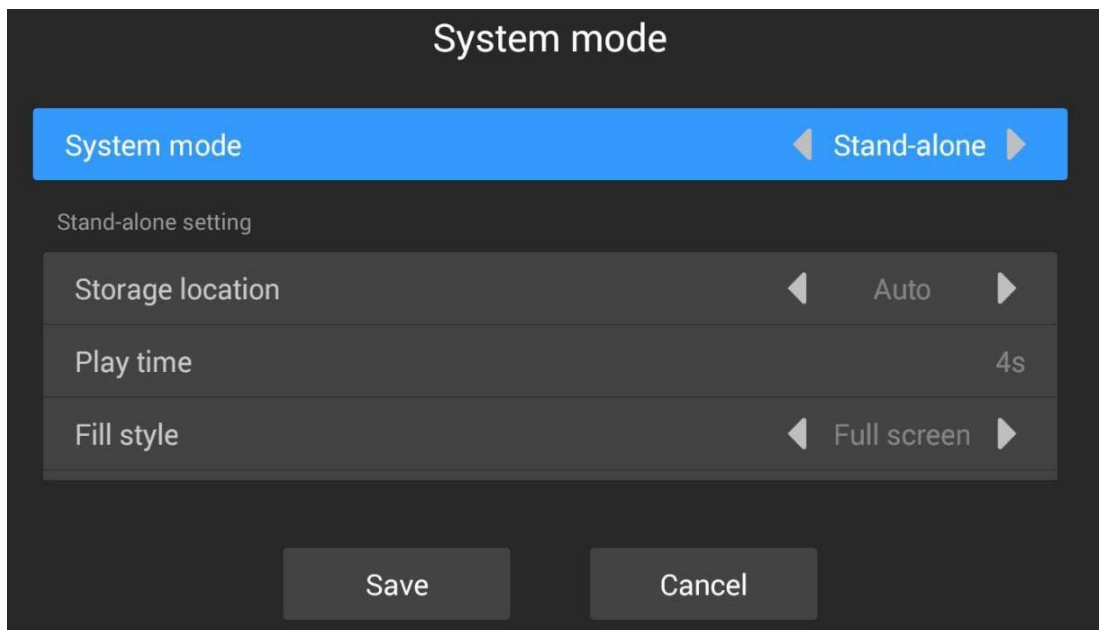

- System mode: stand-alone mode and internet mode (internet mode is still under development and testing ...)
- Storage location: where the program is stored
- Playing time: the time of playing pictures in USB, 5S means playing each picture for 5 seconds (if sent by app, the playing time can be set on app)
- Filling style: Video/image playback in USB is displayed in full screen or scaled in equal proportion

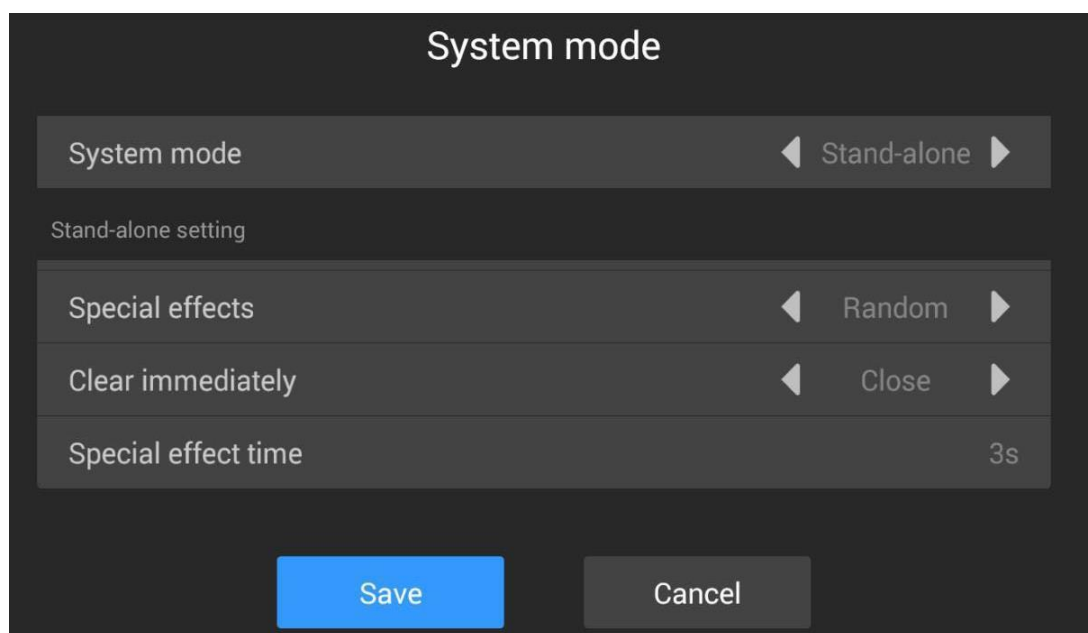

- Special effects: special effects for picture in USB - it has random, still display, pan left, pan right, etc.
- Clear immediately: if On, the previous picture will be cleared, and then the next picture will appear; if Off, the next picture will gradually cover the previous picture
- Special effect time: The time for the picture to appear in the special effect, 3S means it takes 3 seconds for the picture to appear from the beginning to the entire screen

5. Wi-Fi hotspot

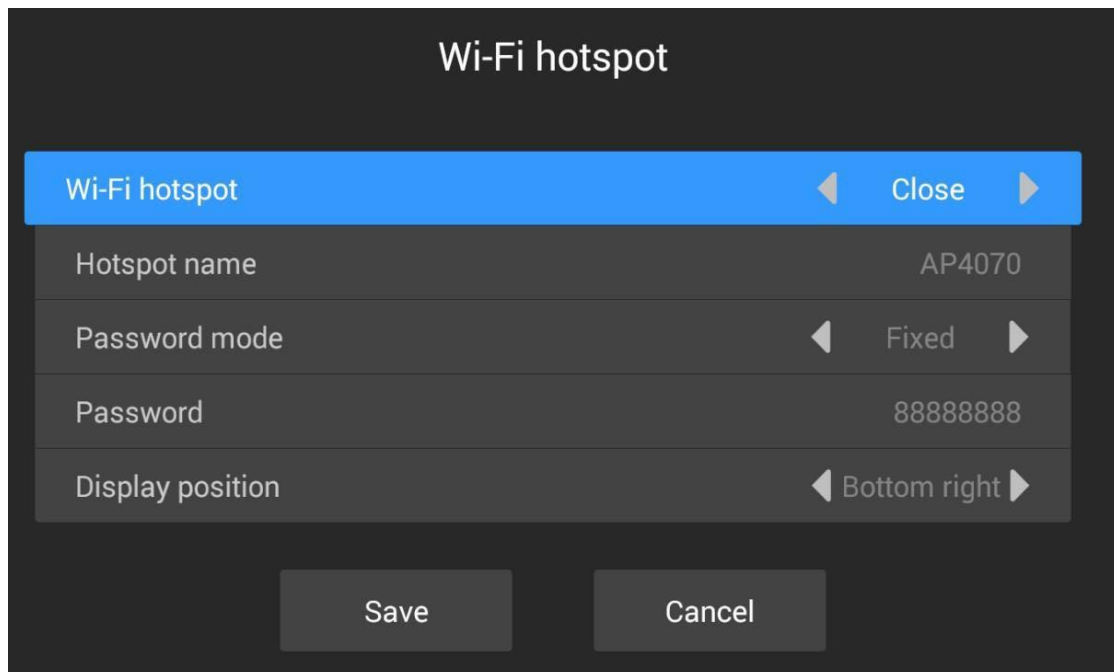

- Wi-Fi hotspot: Turn on this item, the phone can connect to the player's Wi-Fi for control
- Hotspot name: Wi-Fi name, which can be modified
- Password mode: fixed, means a fixed password; random, means the password 30 minutes / 1 hour (can be set) will change once
- Display position: The position where Wi-Fi is displayed on the LCD screen (if the controller cable is connected to the Internet and the phone is connected to Wi-Fi, the phone can access the internet)

11. About

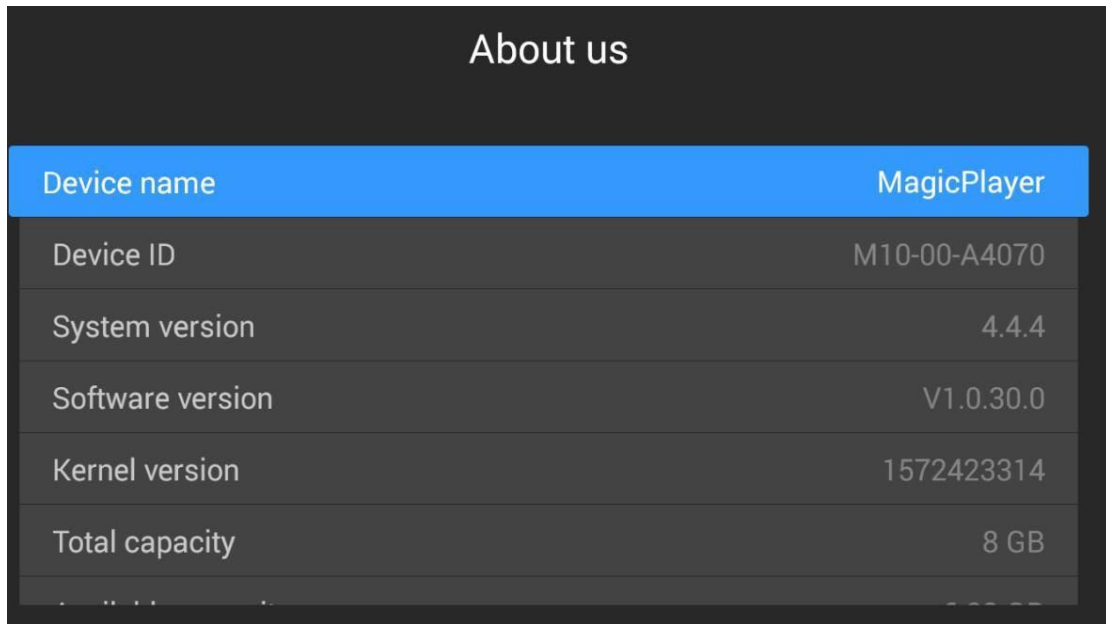

The screenshot shows a dark-themed 'About us' screen. At the top, the title 'About us' is centered in white. Below the title is a table with a blue header row. The table lists various system and device details.

Device name	MagicPlayer
Device ID	M10-00-A4070
System version	4.4.4
Software version	V1.0.30.0
Kernel version	1572423314
Total capacity	8 GB

Controller name, ID, version, capacity, and more.

Unit Specifications

Screen size	43"	49"
Viewable area (W x H)	52.9cm x 94.1cm	60.3cm x 107.3cm
Overall size (W x H x D)	62.3cm x 175cm x 46cm	68.2cm x 180cm x 46cm
Base size	64cm x 46cm	70.2cm x 46cm
Totem colour	Black or white	Black or white
Screen resolution	1920 x 1080 pixels full HD 16:9	1920 x 1080 pixels full HD 16:9
Viewing angle	89°/89°	89°/89°
Brightness	400cd/m2	400cd/m2
Contrast ratio	1200:1	1200:1
Response time	5-7ms	5-7ms
LCD life	50,000 hours	50,000 hours
Display colours	16.8 million colours	16.8 million colours
Frame material	Coated aluminium	Coated aluminium
Screen material	Tempered glass	Tempered glass
Indoor or outdoor use	Indoor use only	Indoor use only
Feet	Rubber	Rubber
Wheels on base	Optional	Optional
Branding on frame	Optional	Optional
Power	Mains powered 240V	Mains powered 240V
Cable length	3m	3m
Screen type	TFT LCD	TFT LCD
Internal storage	16GB	16GB
Speakers	2 x 8W	2 x 8W
Ports	2 x USB ports	2 x USB ports
Operating temperature	0 to 40°C	0 to 40°C
Storage temperature	-10 to 60°C	-10 to 60°C
Relative humidity	20 to 80%	20 to 80%
Weight	55kg	60kg
Delivery method	Palletised for protection during transit	Palletised for protection during transit

Supported image formats

Format	Max resolution	Colour	Size	Attribute
JPG/JPEG	15000 x 15000	RGB	<8M	Baseline standard
PNG	15000 x 15000	RGB	<8M	No interleaving

Supported video formats

Extension name	Video format	Resolution	Frame rate	Bit rate	Audio
AVI	Mpeg4, Divx3,4,5,6, H264	1920*1080	25fps	18M/s	Mp2, Mp3, Aac, Ac3, Pcm
DAT	Mpeg1,2	1920*1080	25fps	18M/s	Mp2, Mp3
VOB	Mpeg1,2	1920*1080	25fps	18M/s	Mp2, Mp3
3GP	Mpeg4, Divx3,4,5,6, H264	1920*1080	25fps	18M/s	Mp2, Mp3, Aac, Ac3, Pcm
MKV	Mpeg4, Divx3,4,5,6, H264	1920*1080	25fps	18M/s	Mp2, Mp3, Aac, Ac3, Pcm
MOV	Mpeg4, Divx3,4,5,6, H264	1920*1080	25fps	18M/s	Mp2, Mp3, Aac, Ac3, Pcm
MP4	Mpeg4, Divx3,4,5,6, H264	1920*1080	25fps	18M/s	Mp2, Mp3, Aac, Ac3, Pcm
FLV	H264	1920*1080	25fps	18M/s	Mp2, Mp3, Aac, Ac3, Pcm
MPG	Mpeg1,2	1920*1080	25fps	18M/s	Mp2, Mp3, Aac, Ac3, Pcm
RM/RMVB	rm	1920*1080	25fps	18M/s	Mp2, Mp3, Aac, Ac3, Pcm

FAQ

Q: Why is my video not playing smoothly?

A: If the video is juddering and not playing smoothly, ensure that the resolution is maximum 1080p. Higher resolutions may not be compatible with the screen, so you will need to decrease the resolution.

Q: How can I convert my video to a compatible format?

A: If the video file is not playing properly on the screen or it does not meet the requirements of the **Supported Video Formats** table, please use the following free **Video Converter** tool, **Format Factory**.

Step 1:

Download and install the free **Video Converter** software for **Windows Vista/7/8/10/11** named "Format Factory".

<https://format-factory.en.softonic.com/>

Step 2:

Open the **Format Factory** software once installed.

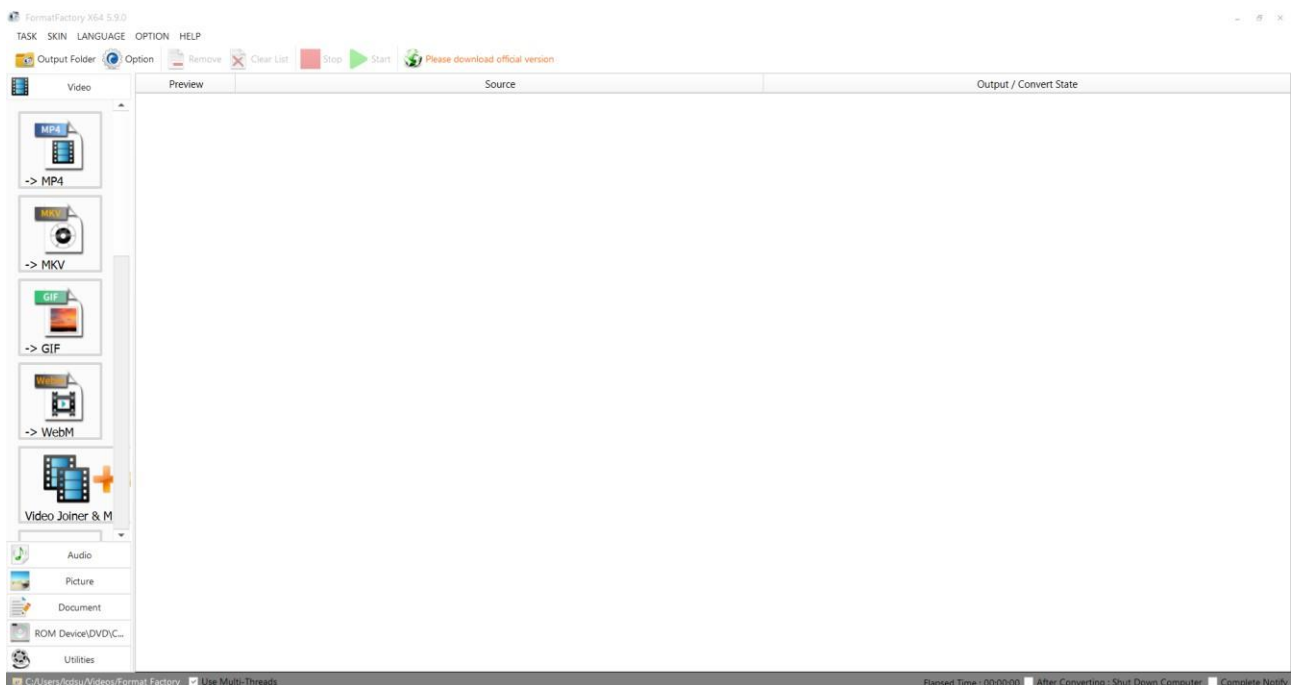

Step 3:

On the left-hand window pane select 'MP4'.

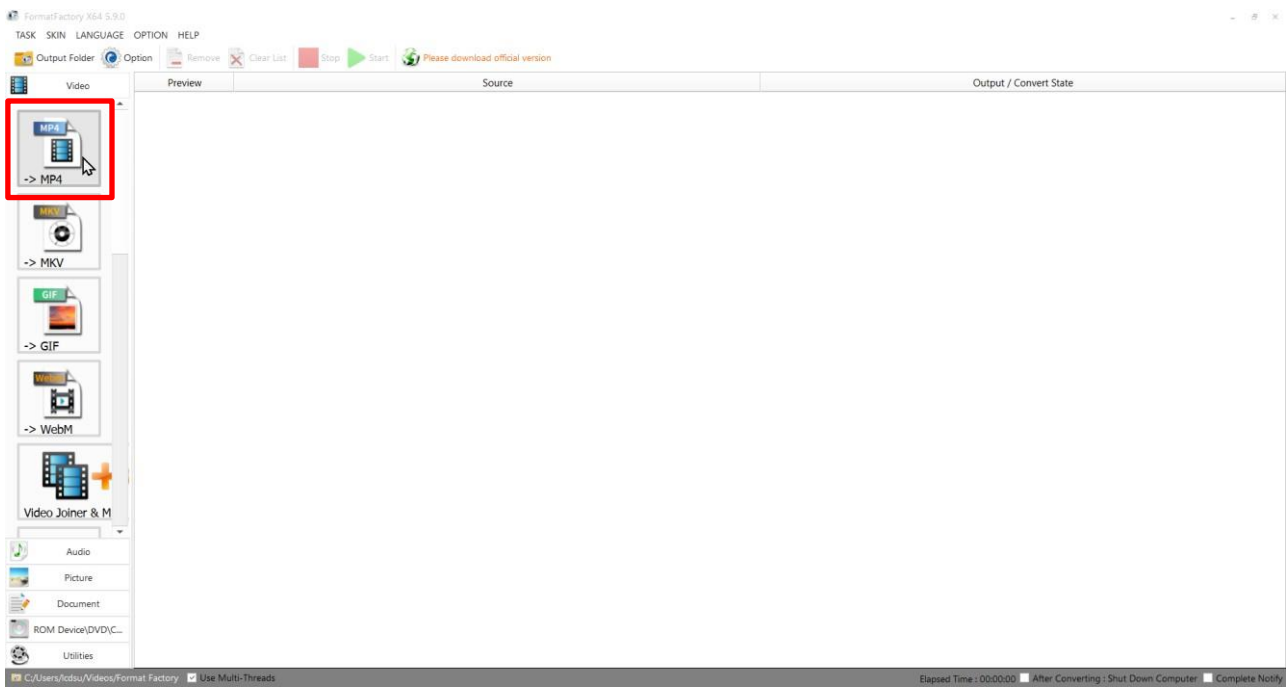
**Step 4:**

Select the 'Add Files'.

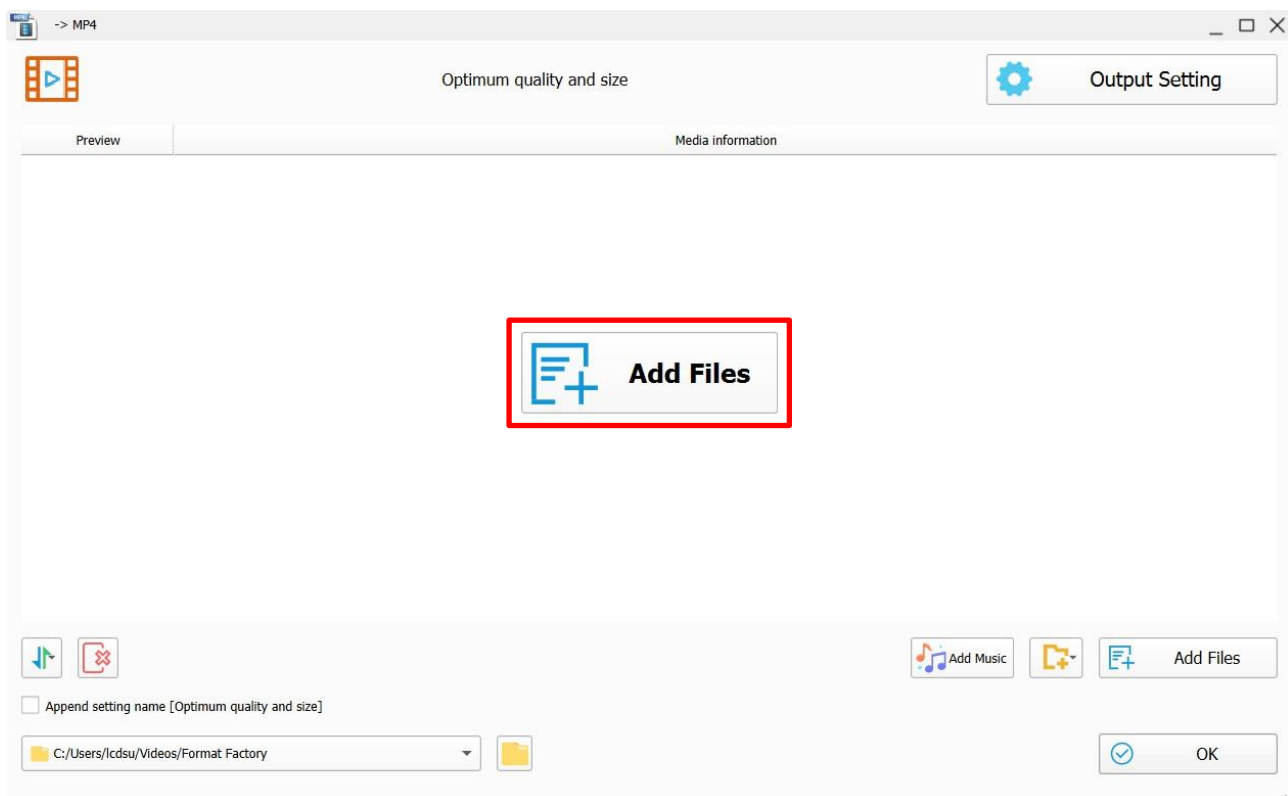

Step 5:

Select the file you wish to convert and press 'Open'.

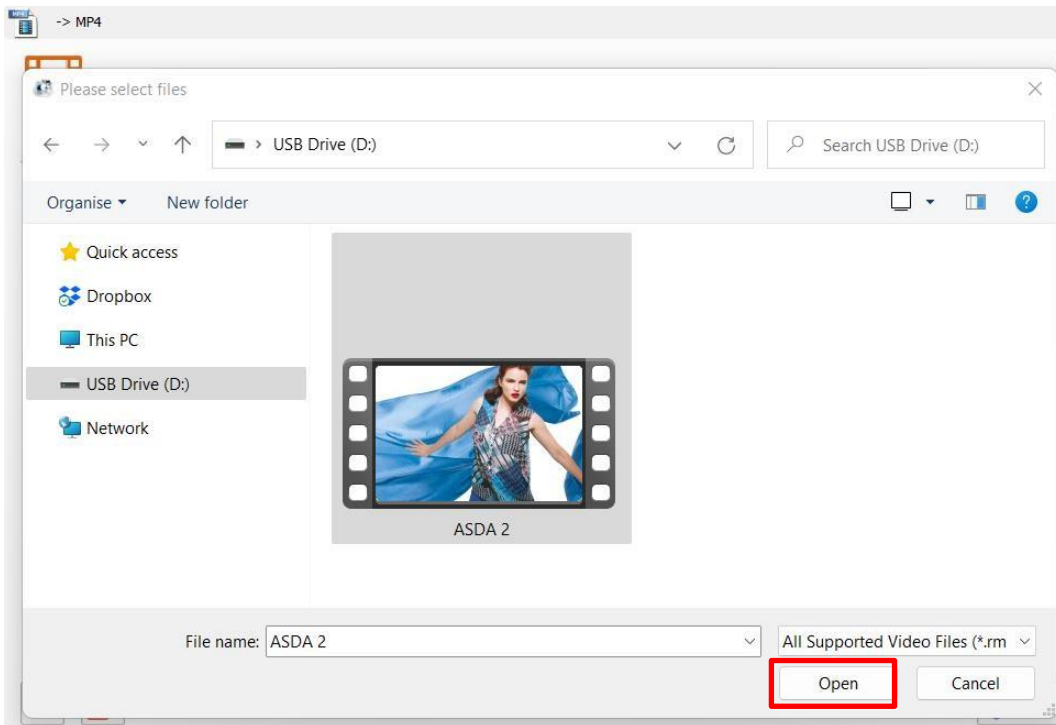
**Step 6:**

Click 'Output Setting'.

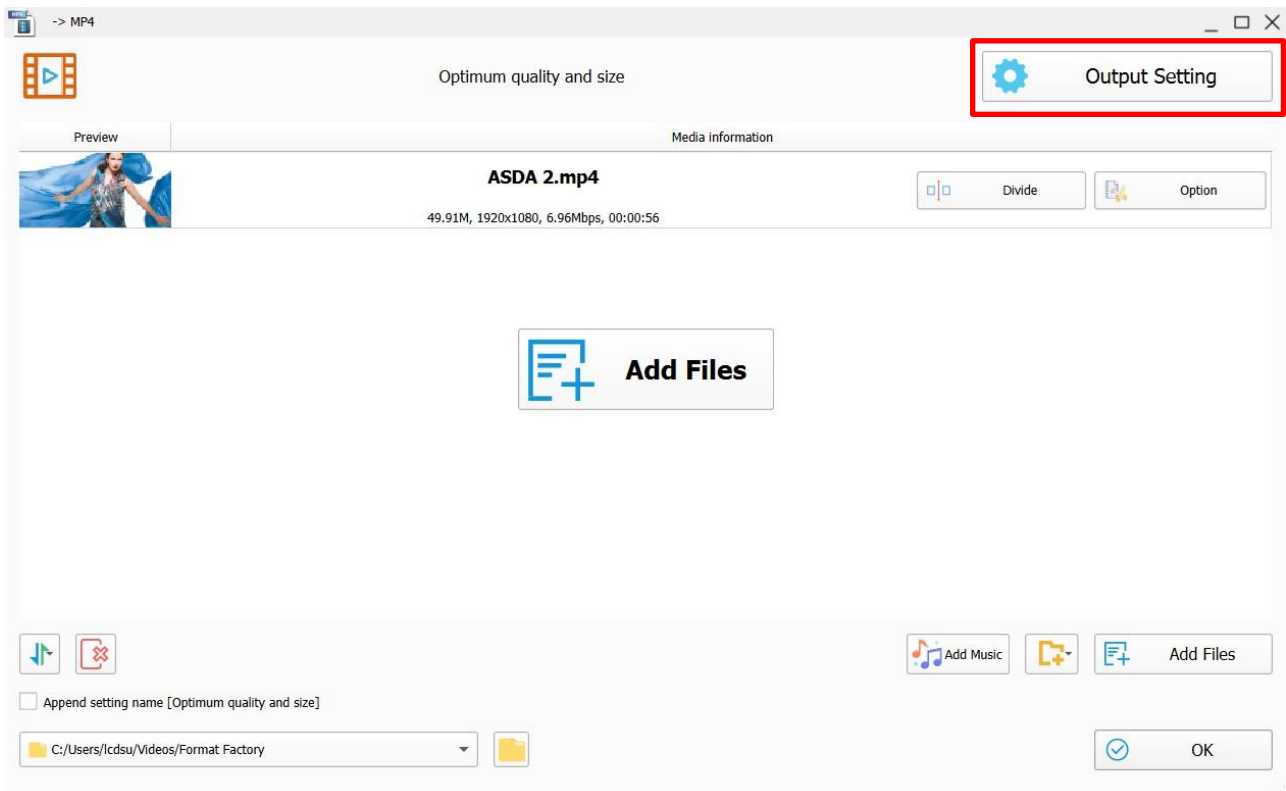

Step 7:

Make sure the 'Video Encode' is set as 'MPEG4(xvid)' for the best quality and to change the 'Video Size' to the recommended resolution is as shown on the Supported Video Formats table.

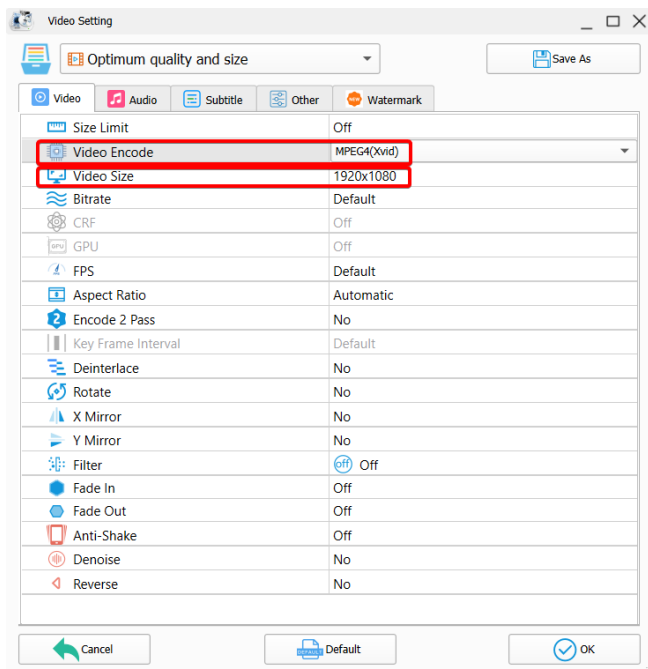

Step 8:

Select the 'OK' button once you are happy with this.

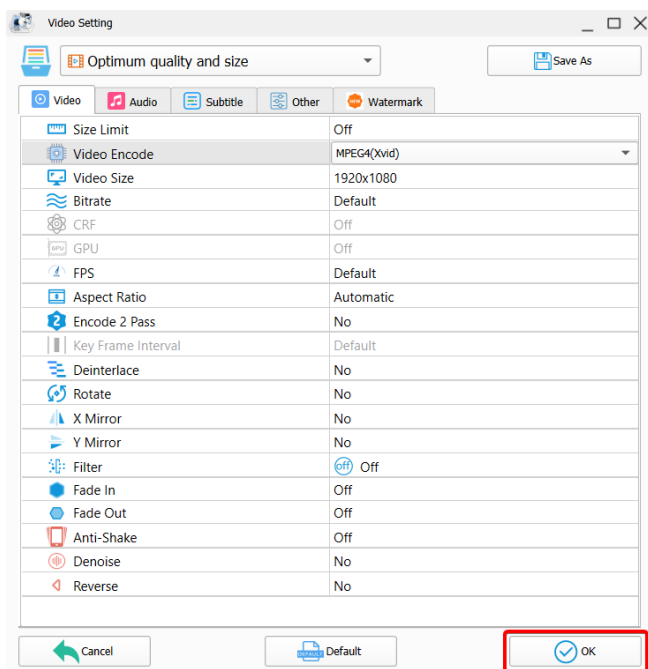

Step 9:

Select the 'OK' button again.

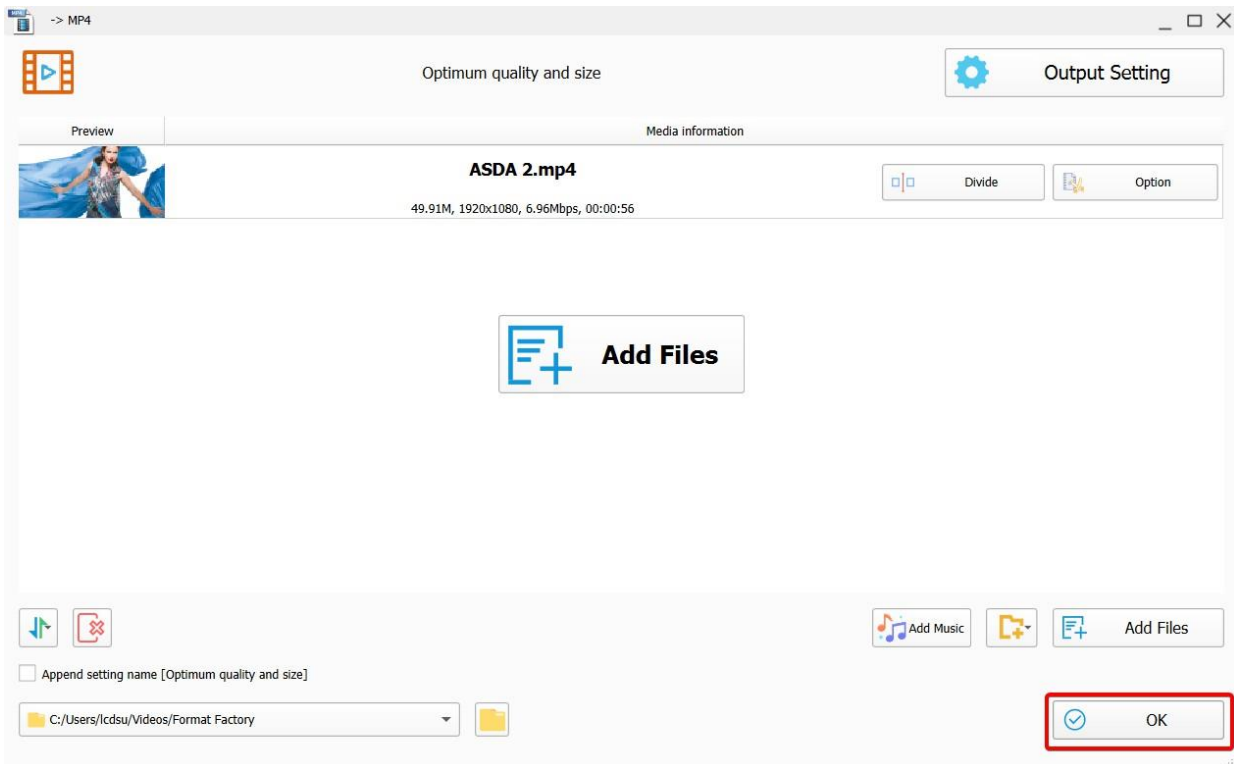

Step 10:

Select the 'Start' button to begin the conversion process.

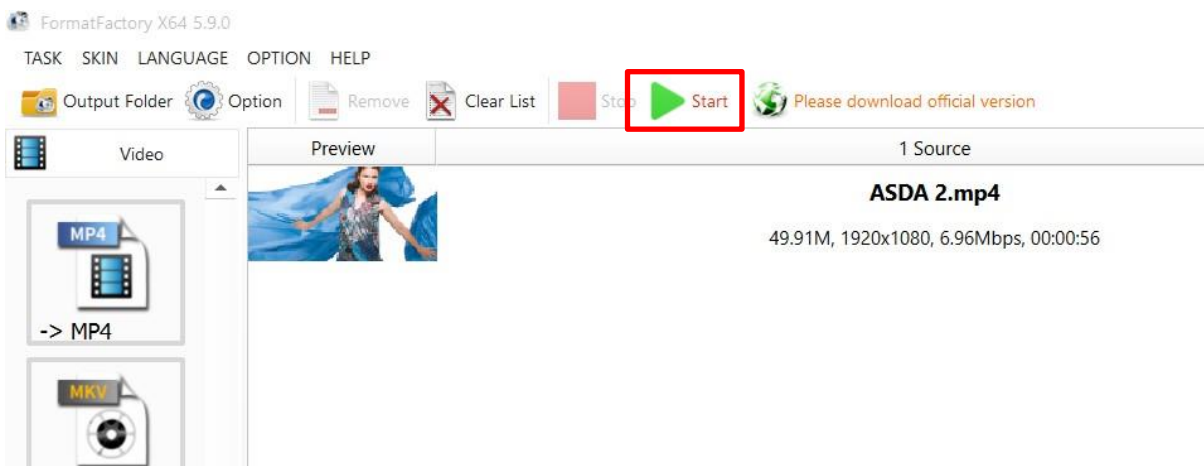

Step 11:

Once the process is finished, select the folder icon to find your new converted video file.

